

TEXA SOLUTIONS



TEXA

Over 30 years of Garage Equipment

TEXA was founded in 1992 from a great intuition that allowed anticipating a true radical change: the introduction of electronic components in vehicles, a trend that shortly after would have become the new standard in the automotive industry. This ability to constantly look ahead, anticipating the needs of repair professionals worldwide, today is still the main reason of the success of this company.

Thirty years of research, development, design, production. A goal that proves the continuous and constant growth of an Italian reality that managed to stand out worldwide thanks to the quality of its products, dedicated to garage equipment, and to its attention towards customers. With the awareness of still having a long way ahead and always new technological trails to trace.

"When I founded TEXA I had in mind a company that would be different from the traditional concept of "factory": a virtuous reality made of people and ideas, always focused on the future. Thirty years later I can say, with great satisfaction, that this ambitious objective has been achieved thanks to the collaboration of a qualified team that shares the same vision".

*Bruno Vianello
President of TEXA*



TEXA solutions

For Garage Equipment

TEXA solutions dedicated to the world of garage equipment are the result of over thirty years of research and development in this field and stand out for their quality design, completeness, safety and user-friendliness.

TEXA developed the most complete range of multi-brand and multi-environment equipment that meets the current needs of mechanics, body shop mechanics, tyre specialists, glass repair specialists, fast-fit centres, and includes: **display units, vehicle interfaces, ozone sanitisers, smart headlight testers**, OBD dongles for **remote diagnosis** on heavy-duty vehicles, **ADAS calibrations systems**, devices for **TPMS control**, equipment for **electric measurements**, emission **analysis tools, hydrogen decarbonisers**, stations dedicated to **A/C maintenance**.

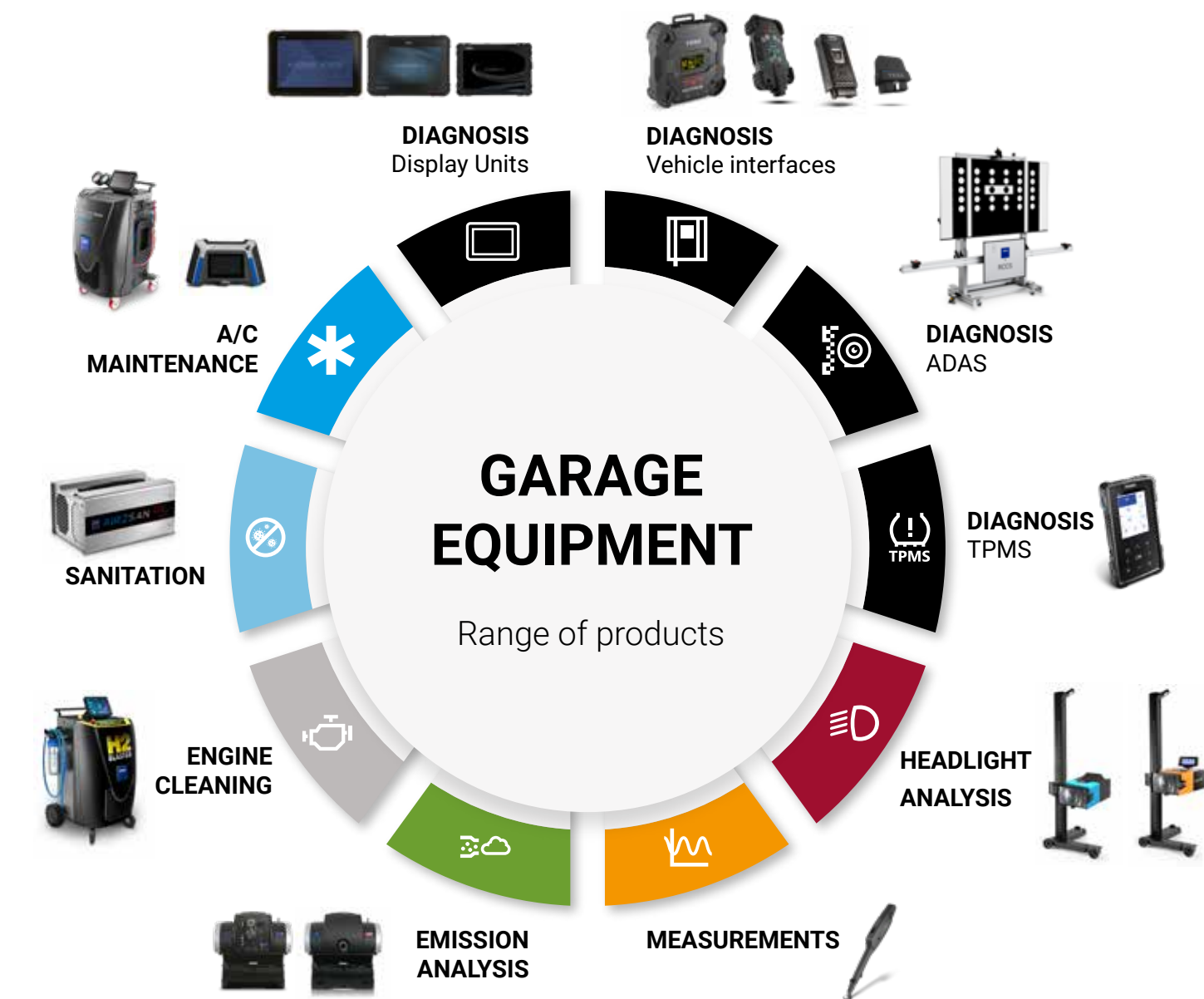

ENVIRONMENTS



MANAGEMENT SOFTWARE



Diagnosis

Display units



AXONE VOICE



Innovative multi-brand and multi-environment display unit, this top-of-the-range tool guarantees that mechanics can carry out quick, complete and precise operations **on all vehicles**. Being the **first hands-free diagnostic tool**, it opens up a new era in the world of diagnostics thanks to its voice control*, facial recognition and large display. It is a **2-in-1** tool as it is fully compatible with carrying out operations in PassThru. It boasts **exceptional hardware equipment**, with the Intel® i5 Quad-core processor, 16 GB LPDDR4 RAM and 512 GB SSD storage. Another distinctive element is the **military standard MIL-STD 810G** (transit drop test), **which makes the tool resistant to impacts and falls**.



Body in magnesium



13.3" Gorilla® Glass Display



Resolution 2560x1600 px



2 Cameras
Rear: 8 MP AF with FLASH
Front: 8 MP



CPU Intel® Core i5



16 GB RAM Memory LPDDR4



512 GB Storage SSD PCIe



Voice control

*Voice control function is available only on selected languages. It requires an Internet connection and an active TEXPACK subscription

AXONE NEMO PLUS



A solution for multi-brand and multi-environment diagnostics that guarantees robustness and durability.

Equipped with a high-contrast **ultra-wide 11.6-inch display** with a 1920x1080 pixel resolution, AXONE NEMO PLUS is powered by an **Intel® N100 processor, a 16 GB RAM and 250 GB SSD storage** for extraordinary performance. The Windows 11 operating system offers an advanced interface. Thanks to the latest-generation Wi-Fi, the connectivity to the company's Internet is quick and reliable. The Bluetooth® 5.3 module allows a rapid connection to the latest-generation vehicle interfaces by TEXA, providing a complete and advanced diagnostic experience. The tool is compliant with the **MIL-STD 810G military standard, which guarantees resistance against drops and falls.**



Ultra-wide 11.6\" data-bbox="113 248 230 272"/>



1920x1080 pixel resolution

Rugged design



Body in magnesium



Intel® N100 CPU

**16 GB RAM
DDR5**

**250 GB Storage
SSD PCIe**

**High-capacity battery:
6990 mAh**



AXONE NEMO LIGHT



Specifically designed for the automotive industry, it offers optimal functionalities in a compact and reinforced design, guaranteeing reliability and performance in any situation. Its advanced technology and the Windows 11 operating system, supported by an Intel N100 Quad Core processor, ensure high performance in the workshop.

With a **10.1-inch bright display, an 8 GB RAM and a 250 GB storage**, the device offers enough space and power to manage data and applications. The reliable connectivity via Wi-Fi and Bluetooth 5.2 modules facilitates access to networks and devices, making **AXONE NEMO LIGHT ideal for continuous use in demanding environments.**

Ultra-wide 10.1\" data-bbox="113 738 230 764"/>



1920x1200 pixel resolution

Intel® N100 CPU



8 GB RAM

**250 GB
eMMC Storage**

6000 mAh battery



* Maximum number of manageable environments: 3 for AXONE NEMO PLUS, 2 for AXONE NEMO LIGHT.

Diagnosis

Vehicle interfaces



TXT MULTIHUB



It is a vehicle interface that allows working on **cars, heavy-duty vehicles, bikes, boats, agricultural and construction vehicles**, in a versatile, quick and intuitive way. It has a built-in display, very useful to view the most important information during diagnosis.

It automatically manages the **CAN, CAN FD*, DoIP, PassThru communication protocols** and the "on board" Linux operating system ensures intelligent connectivity.

The **IP53 certified rugged design** and the MIL-STD 810G military standard (transit drop test) complete the extraordinary equipment on TXT MULTIHUB and make it a true top-of-the-range solution capable of giving its best in every operational situation.



2.42" built-in display



* TXT MULTIHUB supports CAN-FD for CAN 6-14 line.
The CAN FD adapter cable is available for managing multiple lines.

Navigator NANO S



The simplest solution among the vehicle interfaces offered by TEXA.

Being small, light and ergonomic, it allows carrying out all the diagnostic operations on cars, light commercial vehicles, bikes, scooters, quads and jet skis. Every aspect of the Navigator NANO S has been carefully designed and developed to fully satisfy the needs of the modern workshops allowing technicians to complete **all diagnostic tests quickly and easily**.

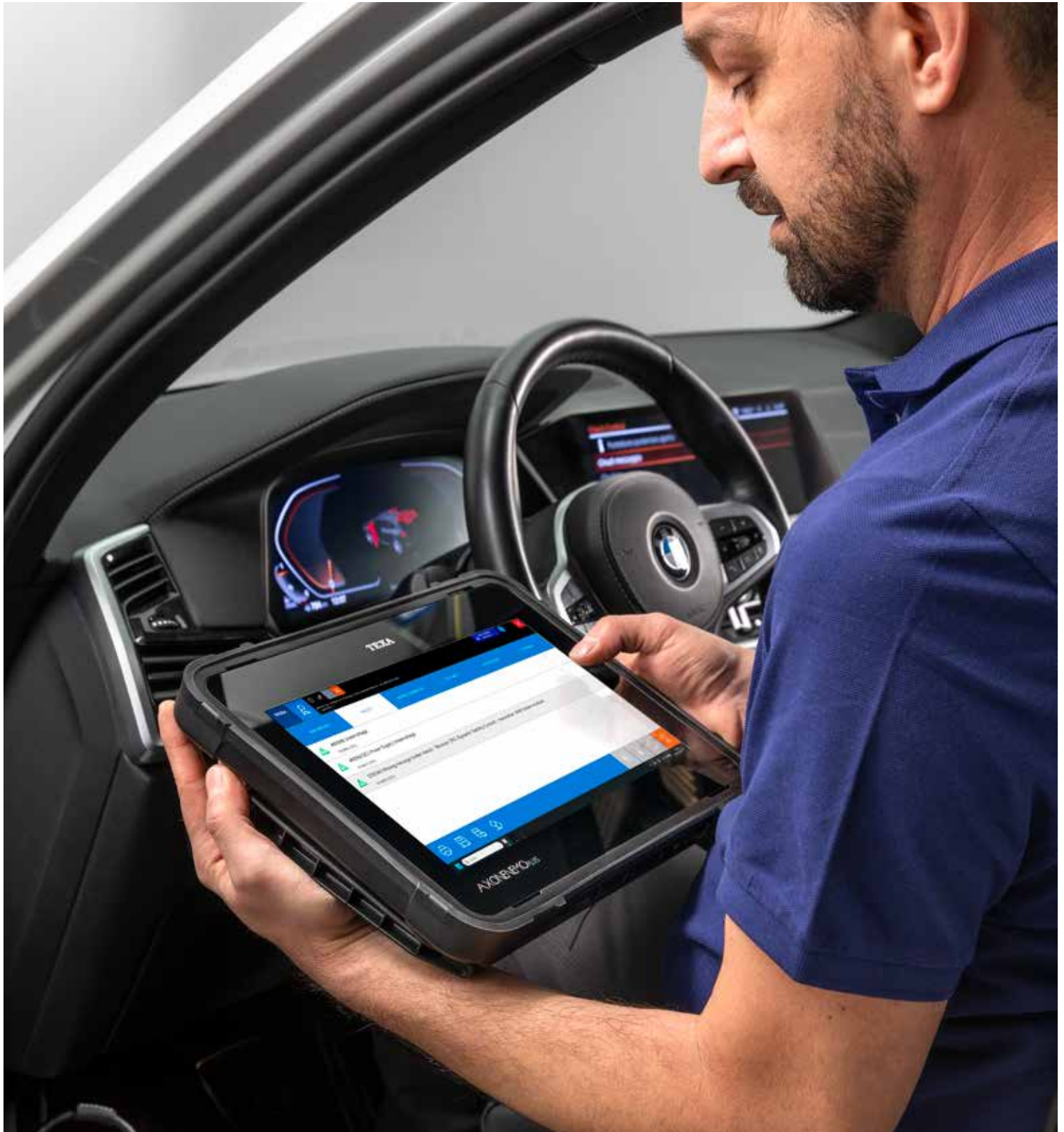

Navigator TXB 2



It is a latest-generation vehicle interface **specifically developed for the bike and marine environments**. The processor used makes it even more fast and powerful and allows a quick and precise processing of the data from the control units, in PassThru mode also. The latest-generation Bluetooth technology and a new USB C socket guarantee faster connection and an optimised data download, other than better useability thanks to the new RGB LEDs. Its hardware features make it compatible with all current protocols and its integrated 16-pin CPC connector allows the use of all the BIKE diagnostic cables. Other than the “classic” diagnosis, it also allows recording the diagnostic session while moving*.



Navigator TXB Zero



A diagnostic interface dedicated to the diagnosis on outboard engines and personal watercrafts. Its design aims at ensuring compatibility with a wide range of engines, offering a versatile and flexible solution for the repair and maintenance needs of specialised technicians. Lastly, it integrates an advanced technology that allows recording the diagnostic tests also while moving*.



* For the diagnostic tests while moving, carefully read and follow the prescriptions you find at: www.texa.com/test-drive. TEXA S.p.A. is not liable for any damage resulting from an improper and non-compliant use of the indications, the sequences and the phases indicated in the page above, in the guide and in the product's user manual.

Diagnosis

Adapters for interfaces

DoIP NODE



It is a multi-brand adapter that **allows carrying out DoIP diagnostic operations at high speed** on vehicles equipped with Ethernet BUS communication.

DoIP NODE represents a great advantage for mechanics who do not have to replace the TEXA tools they already own but simply integrate their operation by using this device whenever the vehicle being worked on requires it.



CAN FD Adapter



The new **CAN FD adapter** is designed to connect to the compatible vehicle interfaces by TEXA, so to allow communication with vehicles equipped with the CAN FD protocol; thus, supporting the operations in **PassThru** and the **diagnosis on multi-channel vehicles** therefore expanding this function even on FCA vehicles with this type of architecture. The CAN FD protocol is among the most recently introduced in the automotive scene and stands out for being much faster, reliable and safe.

Compatible with NAVIGATOR TXT MULTIHUB, TXT with Cortex technology and Navigator NANO S.



Diagnosis

Remote diagnosis

Info Connect 2



Info Connect 2 is the interface that allows accessing the multi-brand remote diagnosis service, developed to complete certain operations that are not available in the software updates yet or that may be complex and unusual for the activities that workshops normally carry out. Its operation is very simple: simply plug the Info Connect 2 interface into the vehicle's diagnostic socket and into your display unit*.

The operator launches the remote diagnosis from the IDC5 software: a TEXA expert enters in real-time, direct communication with the vehicle as if beside the mechanic, and will quickly complete the desired operation.

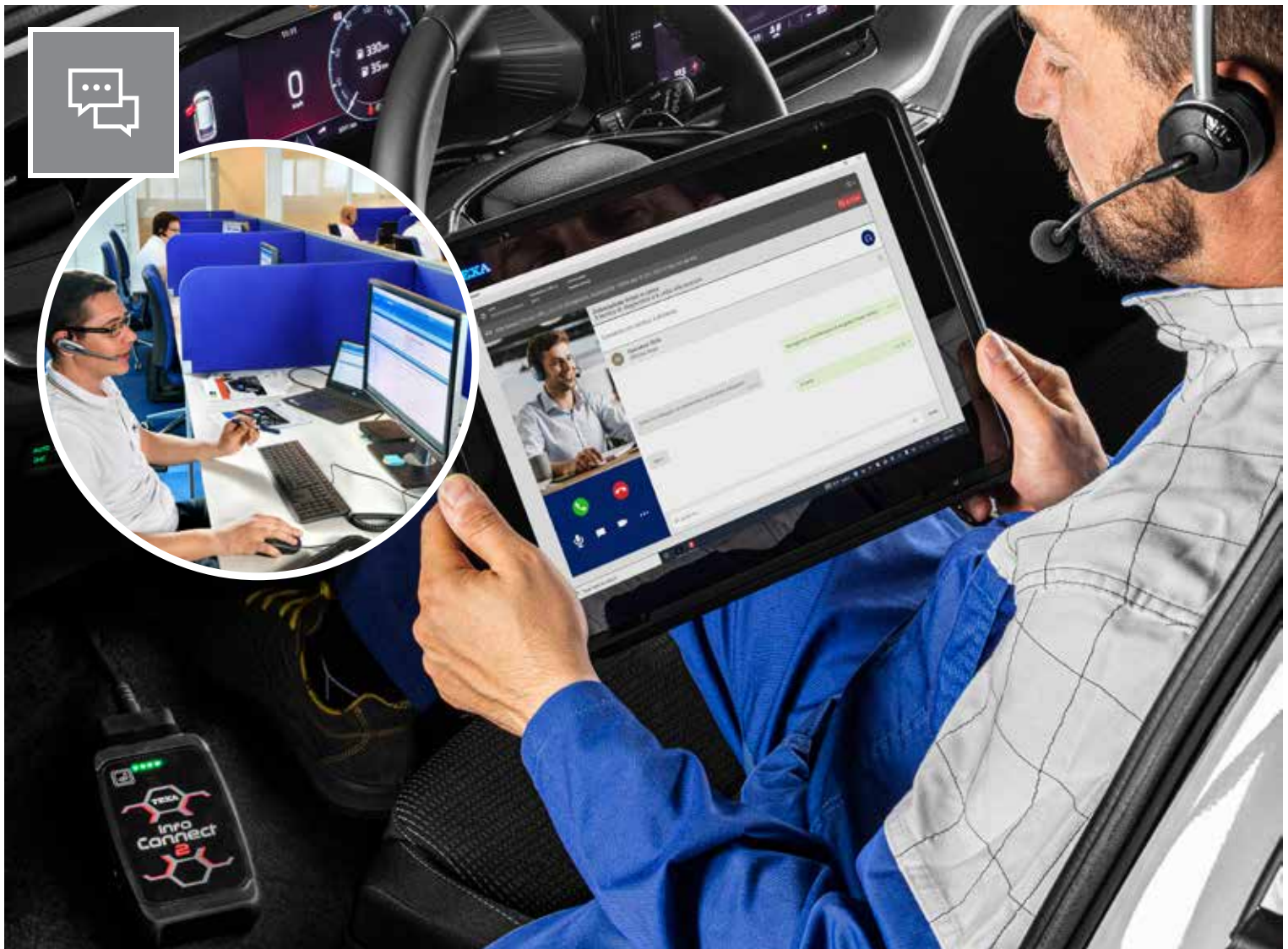

* Info Connect 2 can be used with AXONE VOICE, AXONE NEMO PLUS, AXONE NEMO LIGHT or with a Windows PC and is available for the TEX@INFO Call Center CAR subscribers who signed a REMOTELY SUPPORTED DIAGNOSTICS contract and have sufficient TEXA Points to carry out the specific operation requested.

TEXA eTRUCK



It is a miniaturised solution that takes the industrial vehicle workshop into a new dimension. It is a veritable miniaturised diagnostic tool that, once installed in the vehicle's diagnostic socket* and configured in a few minutes, offers a brand-new type of service. With **TEXA eTRUCK** the workshop can **constantly monitor the vehicle status remotely**, manage its servicing from a predictive point of view and, an absolutely new feature, perform adjustment functions that allow restoring the vehicle's optimal conditions.

* OBD socket or with 9-pin Deutsch adapter for American TRUCKS

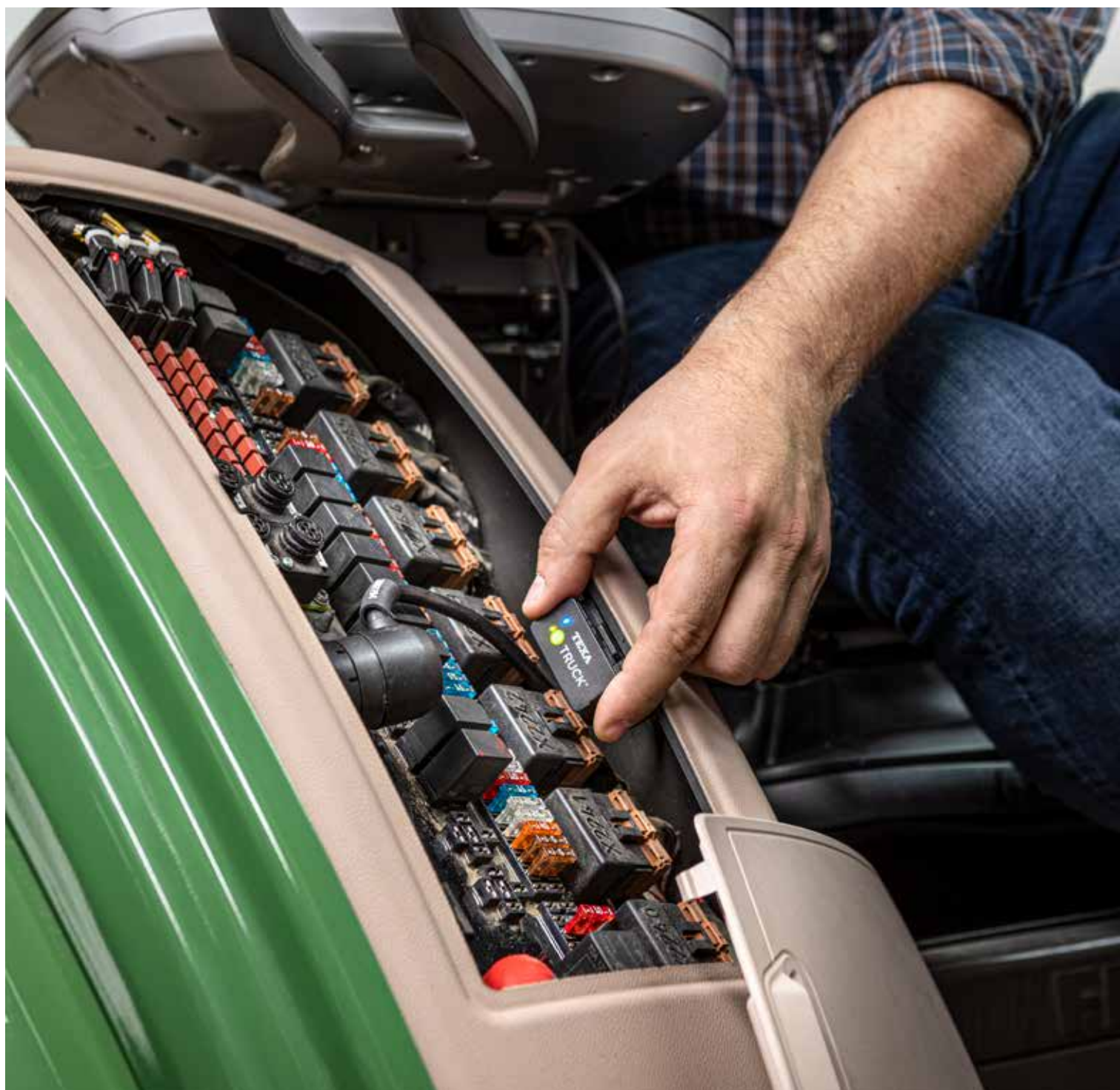

ADAS Diagnosis

RCCS 3 EVO: easy to use, precise and reliable



For the calibration of radars, lidars, cameras and sensors, TEXA has designed and engineered RCCS 3 EVO, a top-of-the-range solution.

The EVO solution guarantees wide possibilities of use as it is even more simple, quick and precise. It can be used with the toe and thrust axis check kit, or in optical alignment mode.

The Bluetooth distance measurers, which can communicate directly with the IDC5 software, make sure the unit is positioned properly by means of a guided procedure. Thanks to the great ease of use and precision of the RCCS 3 EVO system, it is possible to operate safely and in an even quicker, easier and effective way, guaranteeing the final result and the utmost safety both for the driver and the technician performing the calibrations.

The ADAS solutions by TEXA can be used in combination with the other optional devices, to operate fully on additional electronic driver assistance systems, among which:

- **ACS (All Around Calibration System)** allows carrying out the **calibration of the 360° cameras and of the dopplers**.
- **IR Calibration Target and Night Vision System** allow the **calibration of the infrared camera**.
- **Reflector for blind spot radar** essential for calibrating ultrasonic radars.
- **Doppler Simulator** for calibrating blind spot radars. It is an active simulator that responds to the frequency generated by the rear radar on vehicles.
- **A modular 360° mat kit** that allows calibrating the 360° vision system.

RCCS 3 EVO with Monitor

the digital innovation for calibrating the ADAS



RCCS 3 EVO with Monitor is equipped with a 75" HD screen, 4K definition, that always offers an optimal display of the panels, respecting the 1:1 proportion ratio in line with the specifications by each manufacturer. Furthermore, **it does not deform nor resize** the images.

Thanks to a built-in **Mini PC**, RCCS 3 EVO synchronises perfectly with the IDC5 software and the panels are selected and set on the monitor without any risk of error. The **continuous software updates** offer each time new vehicles and possibly new panels, other than essential **help sheets** edited by make and model. This way users are certain they can complete all operations with maximum precision, being able to count on an extraordinary coverage.

75" 4K monitor

1:1 proportion ratio
in line with the specifications
by each manufacturer

**Built-in
Mini PC**

**Robust, and easy
to move and adjust**

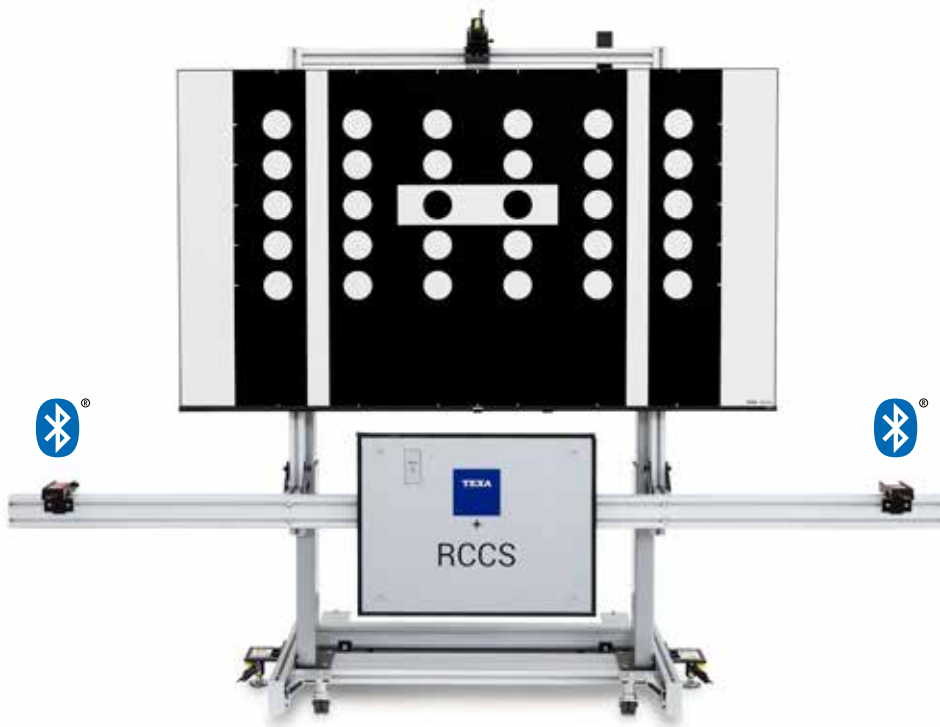

**Bluetooth distance
measurers**



An ad hoc solution for wheel toe and alignment

Before any calibration it is also important to check, other than verifying the calibration unit's alignment, the **toe and thrust angle of the vehicle** being worked on.

These operations are possible thanks to the use of **four CCD electronic measuring heads** (that must be installed both on the wheels, using the rim-clamping system, and on the sides of the horizontal adjustment bar) and the accuracy of the **TOE AND THRUST ANGLE CHECK** software application.



Very performing with the optical alignment also

In addition to the version with toe and thrust angle check, RCCS 3 EVO is also available in the highly performing **optical alignment** mode.

This configuration uses **rim-clamping** and was designed to complete all operations on radars and cameras quickly and precisely.

The vehicle is aligned by the lasers of two **distance meters** mounted on the structure's crossbeam aimed at two practical **pointing bands**.



ARAS BIKE



The TEXA device has been specifically designed for the **motorcycle manufacturers that equip their vehicles with rider assistance systems**. It is an innovative tool that aims at ensuring the utmost accuracy when calibrating the radar systems.

The solution includes adjustable stands, mounting brackets and laser pointers, thus making up an advanced system that provides a complete package to carry out the **calibration of the ARAS in a quick, precise and safe manner**.

CCS 2 Dynamics

It is the first compact and transportable solution



CCS 2 Dynamics is the transportable solution by TEXA for the **calibration of cameras** on **cars, light commercial vehicles** and **heavy-duty vehicles**. It is **compact, stable, and can be easily disassembled** and **transported** in a small-sized van. It can be configured in **two versions** dedicated to the **CAR** and **TRUCK** environments, with specific accessories.

The **Bluetooth distance measurers**, capable of communicating directly with the IDC5 software, guarantee a **correct positioning** through a **guided procedure**. CCS 2 Dynamics is equipped with 4 castor wheels that guarantee a fast positioning, and it can be stabilised thanks to its practical feet.

In the CAR configuration it can be adjusted in height, longitudinally and horizontally. In the TRUCK version, it can be adjusted horizontally and axially. The CAR configuration can be completed with **two alignment modes: optical**, by purchasing clamps, selecting between the tyre or rim version and **based on the thrust angle**, in combination with the toe and thrust axis check kit. The configuration can be **changed easily and quickly**.

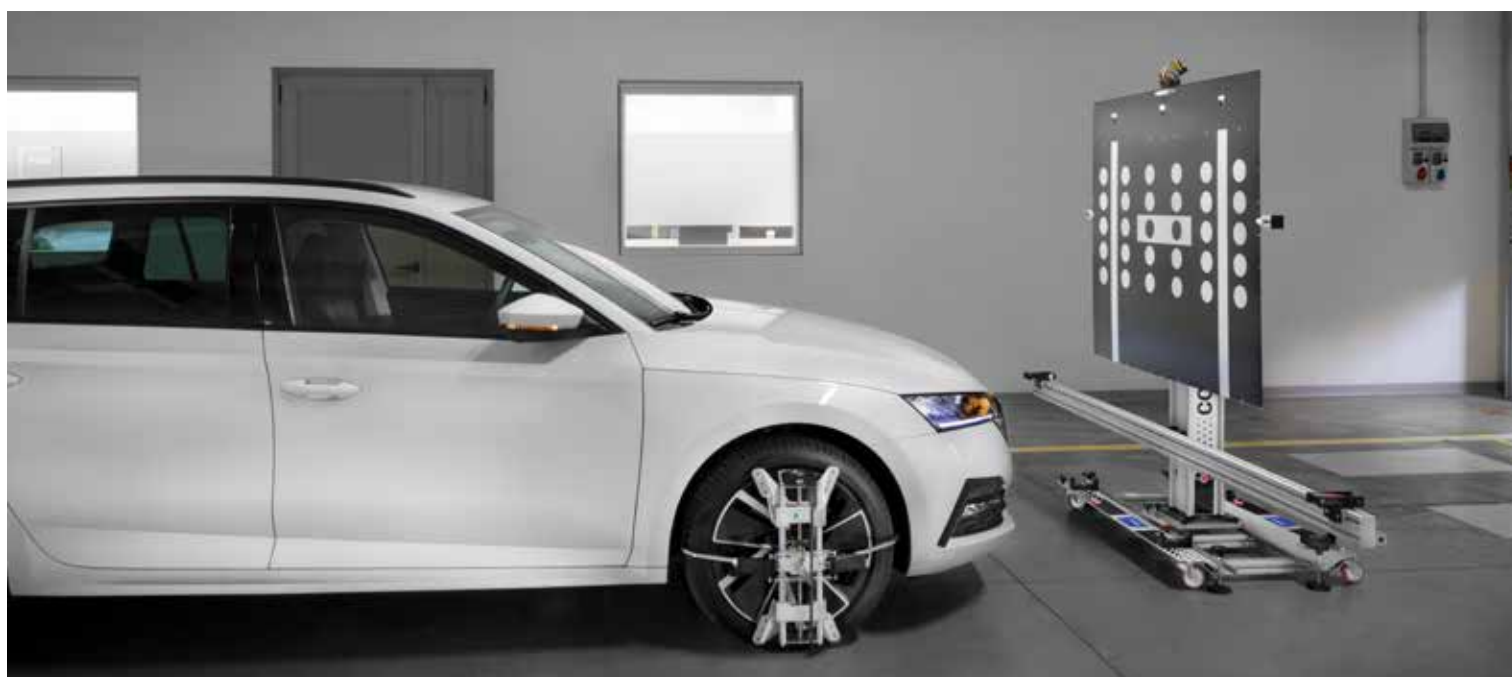

Diagnosis TPMS

Tyre pressure monitoring



TPS2



This tool has been **specially designed for tyre specialists** and for a complete, professional use with TPMS.

TPS2 **boasts a generous, high resolution colour display** that makes reading data and using the tool easy, even in bright sunlight.

A built-in Wi-Fi module allows configuring and connecting to a network for downloading software updates and managing additional functionalities.



Sanitation

Passenger compartment sanitation



AIR2 SAN



Sanitation is an increasingly significant topic, also in the automotive industry.

In this context, workshops, dealerships, vehicle rental companies, taxi companies, road and sea transport companies, fast-fit centres, car washes, fuel stations, and more in general **all the activities relating to the use of vehicles or workplaces, must be able to offer a sanitation service to their customers immediately.**

TEXA has responded to this new need with **AIR2 SAN**, an innovative device entirely designed and built in Italy. AIR2 SAN stands out from the other products on the market for some exclusive features, such as the process that transforms ozone into oxygen at the end of the sanitation cycle. This ensures the correct level of air quality, at the same time protecting the operator and the customer.



Headlight analysis

The first smart headlight alignment system



eLight



The first headlight tester with a built-in electronic diagnostic system. It comes in the **versions ONE and ONE^P**, with the same hardware features. The first communicates with the AXONE VOICE, AXONE NEMO PLUS and AXONE NEMO LIGHT display units to complete the operations, whereas the second is equipped with a **7" colour TFT touchscreen display** that allows technicians to select and activate the various headlight components directly.

eLight allows carrying out all the headlight-related checks on modern vehicles with constantly evolving technologies.

Thanks to the **built-in diagnostics**, capable of recognising the headlight and activating it selectively, technicians can perform the adjustment **saving 50% of the time** needed to complete an operation using a traditional headlight tester. It is **lightweight**, thanks to its aluminium frame, and **easy to carry** thanks to its wheels.



**Measurable light sources:
Halogen, Xenon, LED, Laser**

eLight ZERO



eLight ZERO is the **new entry-level digital headlight tester** by TEXA, developed for inspection centres, body shop mechanics and vehicle repairers. It is able to **interact with the MCTCNet2 networks** via LAN and with a **thermal printer** (optional). Thanks to the **generously sized Fresnel lens** (340x200 mm), it adapts to voluminous and irregularly shaped headlights guaranteeing the execution of all the checks related to the headlights that equip the vehicles.

It has a **lithium battery**, a **5.7" colour TFT touch display** and an **aluminium unit transportable on wheels** that make it **practical and light**.

eLight ZERO **has been approved by** the international certification body **TÜV NORD**.

Measurable light sources:
Halogen, Xenon, LED, Laser



Measurements

Measuring tools



TEXA's new product in the field of measuring tools is **LASER EXAMINER 2**, an innovative laser profilometer to check brake disc and tyre tread wear. TEXA's **UNIProbe** and **TwinProbe** interfaces allow making all the physical measurements you need for a conventional diagnosis, identifying potential faults. **TTC** (TEXA TENSION CONTROLLER), on the other hand, is ideal for the correct tensioning and mounting of the timing belt on bikes, ensuring an extremely professional service.

LASER EXAMINER 2



It is a practical small-sized laser profilometer that **allows you to measure** the **vehicle brake disc wear** with an accuracy of one-tenth of a mm, without having to remove the wheel. Other than this measurement, using a simple adapter, you can also check **the tyre tread wear**. LASER EXAMINER 2 carries out both checks quickly and easily; it allows you to provide customers with an accurate report on the "state of health" of their vehicle wheels, ensuring a professional assistance service and fostering customer loyalty. The **APP** for **LASER EXAMINER 2**, compatible with the **Android** and **iOS** operating systems, allows using the tool directly from a smartphone or tablet.



UNIProbe



UNIProbe includes:

- **Oscilloscope:** four independent analogue channels, complete with SIV* function for interpreting measured signals.
- **Battery Probe:** for testing the battery's efficiency, analysing and checking all the starting and charging systems.
- **TNET:** for the measurement and electrical analysis of CAN automotive communication networks.
- **Signal Generator:** for simulating the pulses generated by sensors and the commands generated by control units and testing solenoid valves and other components.
- **Multimeter:** for voltage, resistance and current measurements (using a clamp-on ammeter).
- **Pressure Tester:** for checking turbo and fuel pressure on all vehicles.

* Indication of the range of values that a properly working component should measure.



TwinProbe



TwinProbe includes:

- **Oscilloscope:** two independent analogue channels with inputs up to ± 200 V, complete with SIV* function for interpreting measured signals.
- **Signal Generator:** for simulating the pulses generated by sensors and the commands generated by control units and testing solenoid valves and other components.
- **Ammeter:** for measuring currents. A BICOR clamp-on ammeter is needed to allow TwinProbe to run these tests.

* Indication of the range of values that a properly working component should measure.



TTC



It is a device for **checking the tension of engine timing belts**, developed following Ducati specifications. TTC measures belt tension by means of a highly sensitive microphone that allows analysing the belt's resonant frequency.



Emission analysis

Exhaust gases, engine speed and temperature detection



TEXA's supply of equipment for periodical technical checks on motor vehicles includes **OPABOX Autopower** (opacimeter to check the fumes emitted from diesel engines), **GASBOX2** (exhaust gas analysis to measure the values of spark-ignition engines), **RC3** (rev counter for light commercial vehicles and heavy-duty vehicles), **RCM** (bike rev counter) and **NP 01** (particle counter).

OPABOX Autopower



OPABOX Autopower is a **partial flow opacimeter** to **check diesel engines** equipped with a fume analysis chamber developed by TEXA and compliant with international standards.

Eliminating cables in the workshop is possible thanks to **Power Pack** and the **wireless Bluetooth technology** for communicating data.

The analysis chamber was incorporated in a practical **trolley with bearing wheels**. This way OPABOX Autopower can be easily transported to reach the vehicle being tested without any effort.



GASBOX2



GASBOX2 is the updated version of the **exhaust gas analyser** for **petrol, LPG, methane engines** equipped with the analysis chamber designed by TEXA, now ever more performing. It can be combined with a **trolley** that allows moving it easily around the workshop. To guarantee a better dynamic of use, other than the traditional socket for a direct connection to the mains, GASBOX2 can be combined with **Power Pack**, a practical extractable module that can be charged separately. This solution allows having one or more batteries charged and always ready for use.



NP 01



NP 01 is a new generation tool that is used for the periodic technical checks on compression-ignition vehicles in some European countries.

More specifically, it is a **particle counter** developed using a **DC (Diffusion Charging) sensor** to measure the particles emitted from the engines within a size range between 23 and 200 nm.

The high-efficiency DC technology allows reaching high measuring standards and makes this device suitable for any need in inspection centres.

Robust and vibration-resistant, NP 01 integrates a **5" touch screen display** for a fast management by the user and a **Wi-Fi interface** to communicate with the viewer software. NP 01 is already arranged to run tests on spark-ignition engines, the next step for this type of checks.



Watch the NP 01
official video



RC3



TEXA developed **RC3** for the detection of engine revs and temperature. The first can take measurements through an inductive clamp and piezo sensor or by the microphone and residual battery signal.

RC3, other than these modes, **can also read the data directly from the OBD socket and operate as an EOBD SCANTOOL.**



RCM



It is the **rev counter by TEXA for the BIKE environment** specific for Otto cycle engines; it is equipped with a display and rechargeable battery.

RCM uses a system that detects the electromagnetic pulses radiated from the ignition system to calculate the engine revs precisely.



Maintenance on A/C systems



KONFORT 700 allows servicing vehicle A/C systems equipped with the **R1234yf**, **R134a** and **R744** refrigerant gases in an efficient, precise and safe way. It is produced on a worldwide unique assembly line and guarantees ultimate quality and lasting reliability. The components used during the assembly phase all have exceptional features and guarantee refrigerant recovery efficiency and filtering above 95%.

The design, with essential and clean lines, confers manageability and robustness and simplifies all operations. From TEXA's great experience in this field, **KONFORT TOUCH** was also created, a range of stations that, thanks to a **multi-touch** display, allows completing all operations in a simple, fast and intelligent way.

THE RANGE OF KONFORT STATIONS IS APPROVED BY:

AUDI
BENTLEY
BMW
BUGATTI
CHEVROLET
HYUNDAI

JAGUAR
KIA
LAMBORGHINI
LAND ROVER
MAZDA
MERCEDES-BENZ

MINI
MITSUBISHI
NISSAN
OPEL
PORSCHE
RENAULT

SEAT
SKODA
SUBARU
SUZUKI
TOYOTA
VOLKSWAGEN

Check with your TEXA Distributor the model and type of refrigerant recommended from each individual car maker listed.

780 TOUCH



This is the top-of-the-range in the 700 series and the best the market has to offer. It is equipped with a **double tank** and **two distinct circuits** for recovery, recycling and recharging. This allows intervening both on vehicles that use the R134a refrigerant and on the ones that use R1234yf simultaneously

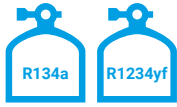

760 TOUCH/760 BUS TOUCH



In both versions the management of the maintenance service is completely automated. The **BUS version** is specially designed for use with larger A/C systems. It is **equipped with a 30 kg tank** and a 21cc refrigerant recovery compressor. They can be arranged for either R134a or R1234yf.

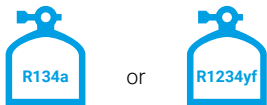

720 TOUCH



It is an **entry level** station able to operate on all the systems on cars, light commercial vehicles, industrial vehicles and tractors without compromising on the technology of the KONFORT range. It can be delivered preconfigured for the traditional R134a refrigerant gas or for the new R1234yf.

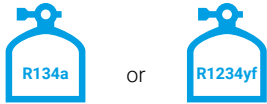

770S TOUCH



The refrigerant gas tank is positioned on a robust electronic scale, with a safety system that prevents altering the calibrations when transported. It comes with an automatic leak detection system and EN837 Class 1 certified pressure gauges.



744



It was specifically built to interact with the **new A/C systems based on the use of the R744 refrigerant (CO₂)**. It achieves the highest possible levels of precision. In fact, the quality of its components and its design allow extreme recharging accuracy, with a maximum tolerance of only 10 grams (2 grams for oil).



Watch the official video
on KONFORT 744



712 TOUCH



It is a **mid-range** model which boasts the typical technical features of the top-range models such as the automatic maintenance service management and the measuring of the amount of oil recovered with an electronic scale. It can be purchased in the R134a or R1234yf version.



710 TOUCH



Although it is a **basic model**, it offers a series of key functions that feature the KONFORT 700 Series, including automatic leak detection, refrigerant check with electronic scale, automatic timed oil and UV tracer injection, and high efficiency refrigerant recovery (over 95%).



707 TOUCH



This station works with the R1234yf refrigerant. **Essential and simple to operate**, it nevertheless incorporates all the latest design solutions. Its main features: a dryer filter that allows performing up to 300 maintenance services; scale locking system; alphanumeric keyboard; 4 castor wheels; and a maintenance log with data on all services completed. **It is also available in the OFF-ROAD version.**



705R



TEXA's entry level solution dedicated to the R134a refrigerant. It is ideal for workshops that wish to offer impeccable service while keeping their business costs low. KONFORT 705R has the same features as the other models that are part of the KONFORT range. **It is also available in the OFF-ROAD version.**



REFRIGERANT IDENTIFIER KIT

This device immediately identifies the type of refrigerant in the vehicle, R134a or R1234yf and **checks its pureness**. The entire operation takes approximately one minute. If the refrigerant is found to be unsuitable or contaminated, the charging station warns the technician and blocks the operation.



TXR ID



TXR ID is the new **portable refrigerant identifier** that allows **identifying the type of gas, R134a or R1234yf** in the vehicle or in the tank for recharging and **checking its pureness**. This device, thanks to the **activated carbon filter** designed by TEXA, allows an accurate analysis that is not compromised by external factors.

Using TXR ID **guarantees carrying out an A/C system recharging service properly**, eliminating risks and the costs caused using a refrigerant that is not appropriate. Furthermore, the software interface with **guided procedure**, the **5.4" touch screen display** and the **Bluetooth and Wi-Fi modules** allow completing all the operations easily, quickly and automatically.

R134a or R1234yf

Built-in software interface

Built-in Bluetooth and Wi-Fi modules



Activated carbon filter

5.4" touch screen display

Complete test in 30 seconds



Engine cleaning

Restoring optimal engine performance

Which advantages are gained after the treatment with

H2
BLASTER

- ✓ fuel economy
- ✓ reduced harmful emissions
- ✓ DPF and EGR cleaning
- ✓ cleaning of the internal parts of the engine without having to remove them

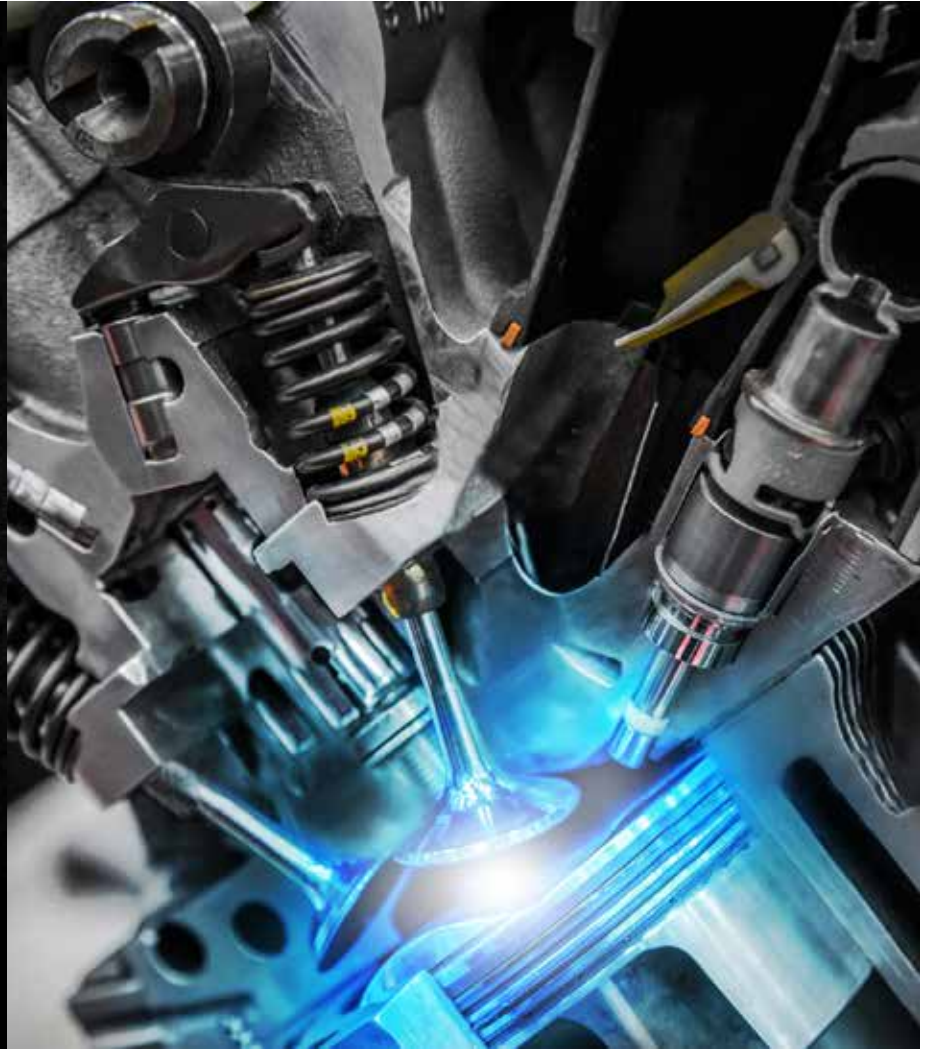

H2 BLASTER



H2 BLASTER, cleans all the **engine** components involved in the internal combustion process and restores optimal performances, reducing consumptions and harmful emissions.

Through electrolysis H2 BLASTER generates **oxyhydrogen**, a mixture of hydrogen and oxygen that, with the engine running and warm, is injected **into the intake manifold** through a practical service pipe and reaches the combustion chamber.

Here the **gas** is triggered by the high temperature and **transforms into high-pressure water vapour**. This is how the **decarbonation process** begins: the water vapour penetrates the scales and dissolves the carbon deposited on the pistons, valves and injectors and in general on the components that are between the chamber and the exhaust duct.



IDC5: the Multi-level Diagnosis

TEXA's approach to diagnostics

The multi-level diagnosis is the **answer given by TEXA to the increasing complexity** in the world of diagnosis. A new approach that allows repair technicians to **carry out all the operations**, even on particularly recent vehicles or in case of **locks set by the manufacturers**.

Regardless of the operation to carry out, the vehicle repairer can benefit from an **assistance service specific for every need**.

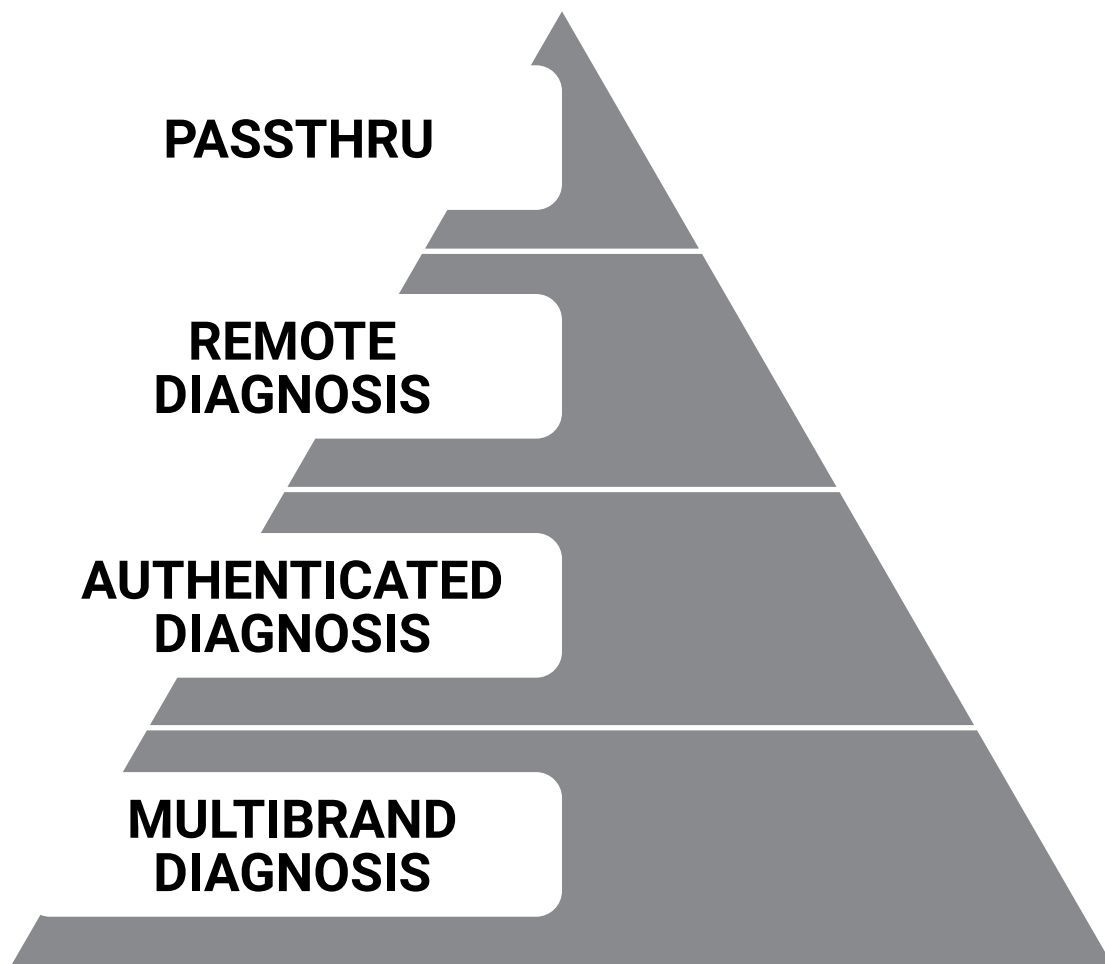

The diagnosis can be represented as a multi-level pyramid, the base of which consists in multi-brand diagnosis and its peak is the PassThru. During the repair, different diagnostic paths can be followed.

Specific assistance and functionality for every need



TEXA's offer considers a series of essential factors for vehicle repairers: the degree of **complexity** and the **type of diagnostic operations**, the possibility to **operate even if there are gateway or control unit locks** imposed by the manufacturers and the possibility to receive **remote assistance**.

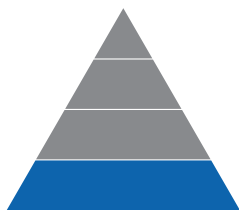

MULTI-BRAND DIAGNOSIS

The multi-brand diagnosis is at the root of the concept of Multi-level Diagnosis by TEXA. Via the IDC5 software vehicle repairers are **guided throughout all the diagnostic phases**, from the identification of the error up to its solution. TEXA updates IDC5 constantly, expanding its coverage of makes and models, adding new exclusive functions, increasing the **technical documentation** and improving the **support services**.

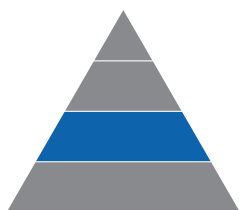

AUTHENTICATED DIAGNOSIS

The authenticated diagnosis represents the second level and, thanks to the collaborations with vehicle manufacturers, allows **unlocking the gateways or the control units** inhibited by the manufacturers. This function is **perfectly integrated in the IDC5 software**, so to guarantee users a consistent experience without elements of complexity.

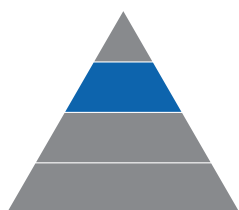

REMOTELY SUPPORTED DIAGNOSIS

The third level of diagnosis is the **remote diagnosis** through the **Info Connect 2*** interface or the **remote PassThru Assistance*** support provided by the Call Center for vehicle repairers.

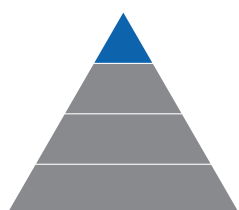

PASSTHRU

The peak of the multi-level concept is the PassThru, **the connection with vehicle manufacturers** (Euro 5/6 vehicles) to receive diagnostic, service and maintenance data.



* services available only in some countries.

Diagnostic software

IDC5 software licence

IDC5 is **the core of the diagnostic solutions by TEXA**.

It is a software that guides technicians throughout all the diagnostic phases, from the identification of the error up to its solution, always in a practical, safe and professional way.

It constantly updates and increases its coverage of makes and models, to help repair professionals solve typical problems that arise during their everyday work.

IDC5 also offers a series of exclusive functions and technical documentation that exceed the traditional concept of diagnosis. Among these: automatic vehicle search, TGS3s control unit scan, dashboards, interactive wiring diagrams, guided diagnosis, solved problems, technical bulletins, mechanical data and error help sheets.

Strong points of IDC5

Diagnostic coverage

The software remains up to date with the evolution of the vehicle market worldwide thanks to the **continuous updates** included in the subscription. A world of information organised by make, model and engine type, and the possibility to examine in depth by consulting: **database, wiring diagrams, technical bulletins** and **solved problems**.



Software speed

The **speed** of IDC5 in entering into **communication with the vehicle** and in all the **diagnostic phases** allows a higher **efficiency**, reducing the diagnostic operation times.



Thorough adjustments

The thoroughness of the **diagnostic adjustments** developed by TEXA and included in the software makes them comparable to the official testers of each brand, guaranteeing an optimal autonomy.

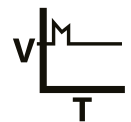

Dashboards

One of the exclusive functions available in the IDC5 operating software, the DASHBOARDS offer the possibility to **view the vehicle's engineering parameters**, associated with **intuitive captivating graphics** that reproduces a vehicle dashboard, the mechanical components and the system's operating logic.



OE diagnosis

TEXA's diagnosis allows performing **multi-brand diagnosis** using enhanced communication protocols, such as **DoIP** and **PassThru**, easily and quickly.



OE functions

IDC5 integrates some **specific functions of the manufacturer's diagnostics** into the multi-brand diagnosis, allowing operators to carry out advanced operations without having to use an original tool.

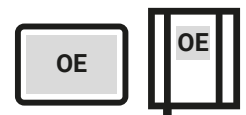

Multi-brand, multi-environment

A single software for all environments

IDC5 is designed and developed following a multi-environment logic, to be used effectively on **cars, light commercial vehicles, trucks, agricultural** and **construction vehicles, bikes** and **boats**.

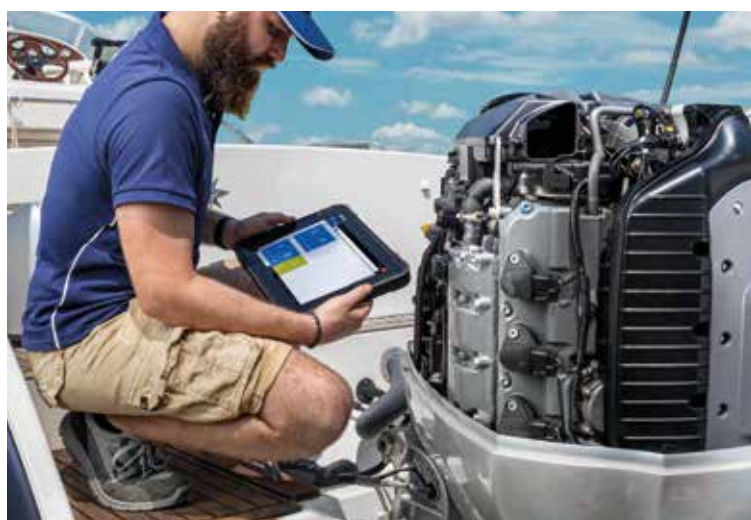
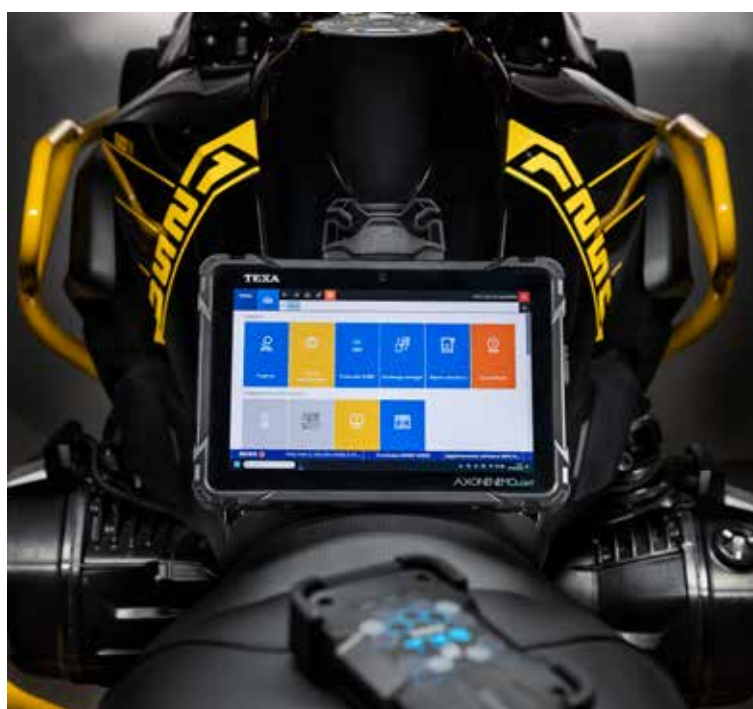
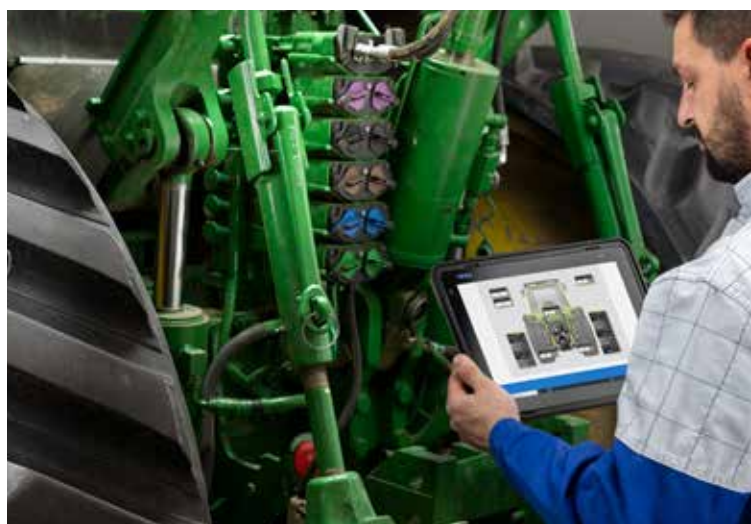
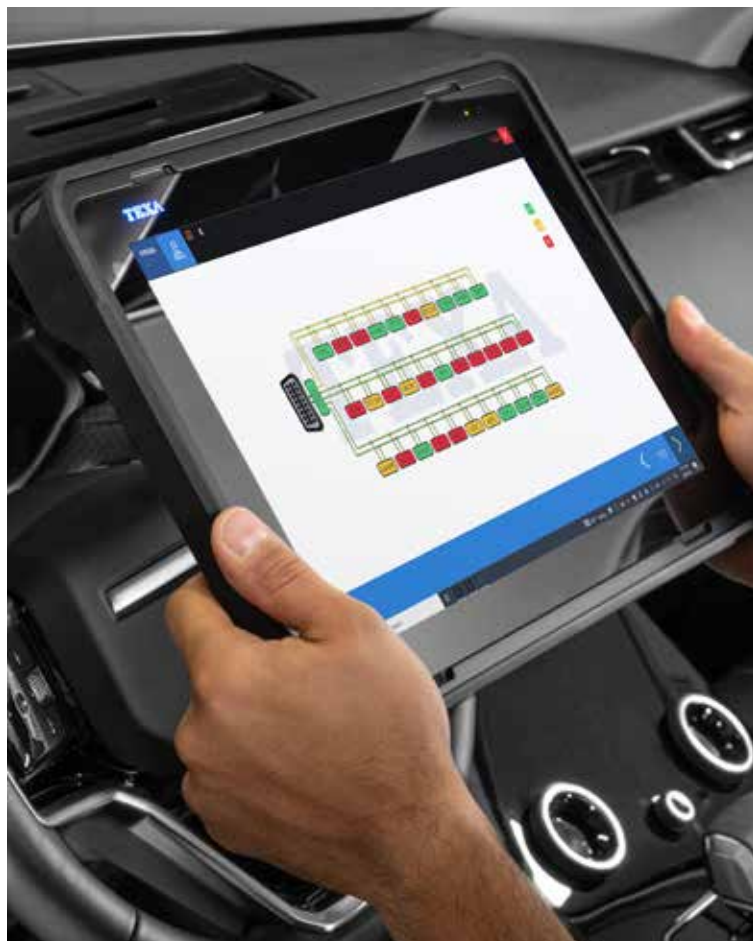

Updates and Services

TEXPACK subscription



TEXPACK software update

It is the annual update contract **for the five environments** (CAR, TRUCK, BIKE, OFF-HIGHWAY and MARINE) that allows using the diagnostic tool to the **best of its potentials**.

Thanks to TEXPACK, you are constantly **updated on the latest new features on the market** and the **most recent coverage of makes and models**.

Furthermore, TEXPACK allows **taking advantage of the evolution of the IDC5 software**, being immediately able to use both **new functions that are released** between one version and another, and the ones already available, such as:



TGS3S SYSTEM GLOBAL SCAN



DASHBOARDS



HELP SHEETS



TECHNICAL DATA



WIRING

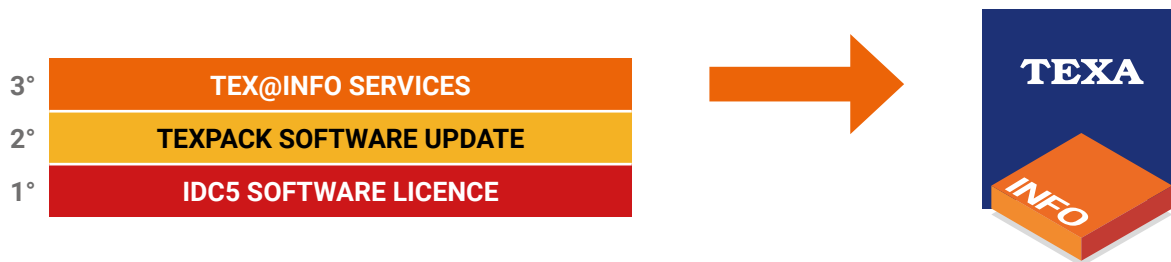

DIAGRAM TECHNICAL SHEETS

TEXPACK = MAKE AND MODEL COVERAGE + SOFTWARE FUNCTIONS + NEW FEATURES

Updates and Services

TEX@INFO subscription



TEX@INFO Services

It is the annual contract that allows selecting which assistance services to activate based on the operational needs and includes:



TECHNICAL BULLETINS

To receive and view information on frequent problems and related repair procedures, operating principles of an electronic or mechanical system, procedures to find the solution to the problem. All this thanks to documents filed by vehicle, enhanced with images or easily interpretable comparative charts.



SOLVED PROBLEMS

It allows accessing TEXA's diagnostic databases easily to search for repair procedures already encountered and registered by our Call Center technicians.

This way vehicle repairers can access, 24/7, thousands of practical troubleshooting cases, tested on site by mechanics all over the world.



CALL CENTER / iSUPPORT

Needed to contact the TEXA phone support centre and receive assistance by qualified technicians that guide the user towards the solution of the fault in a few simple steps. An alternative that can be used is iSUPPORT, a service that allows asking for technical support directly from the diagnostic tool for the solution to any possible problem. TEXA also offers a dedicated ADAS line to answer any question and solve any need.



CAR Environment

IDC5, TEXPACK and TEX@INFO

The IDC5 CAR diagnostic software guides vehicle repairers throughout all the diagnostic phases, from the identification of the error up to its solution, for vehicles such as **cars**, **supercars** and **light commercial vehicles**.

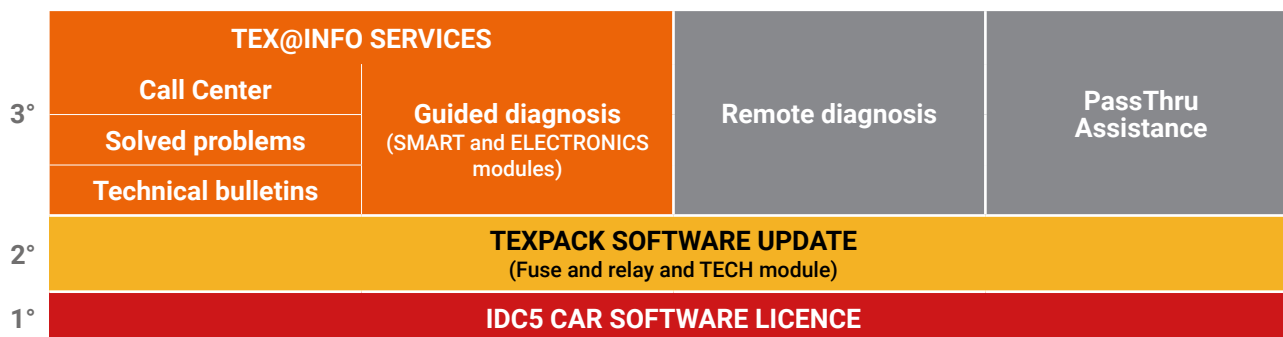

DATABASE BUILT INTO IDC5*

The new technical contents are perfectly integrated inside the TEXA IDC5 diagnostic software and can be reached from the main menu at the item "Technical data and checks", from the TGS3 vehicle scan in correspondence of any DTC that may be present, or from the diagnostic system thanks to a direct link.



TECH module

Maintenance and technical data, repair manuals, technical illustrations and drawings, repair times, estimator and recalls.

Included with TEXPACK CAR



ELECTRONICS Module

Guided procedure for the solutions of the fault by identifying, locating and solving the errors related to the electrical system and components.

Included with TEX@INFO - Guided Diagnosis



SMART Module

Many solved cases and OEM service technical bulletins divided by symptom, cause and solution.

Included with TEX@INFO - Guided Diagnosis

PROTECTED CONTROL UNIT AND GATEWAY UNLOCK

TEXA has always been looking to the future, thus guaranteeing the best diagnostic coverage on the market and meeting the needs of vehicle repairers forced to overcome the locks imposed by the manufacturers.

List of the makes covered by the protected control unit and gateway unlock service:**



Included with TEXPACK CAR

ABARTH

AUDI

ALFA ROMEO

CHRYSLER

CUPRA

DACIA

DODGE

FIAT

FIAT PROFESSIONAL

JEEP

KIA

LANCIA

RENAULT

SEAT

SKODA

VOLKSWAGEN

VOLKSWAGEN
COMMERCIAL
VEHICLES

* HaynesPro® contents

** function subject to territorial limits. Check the service(s) availability in a specific Country with your distributor.



DASHBOARDS IN DIAGNOSIS

The DASHBOARDS allow understanding the system's mechanical components and operating logic all within a single screen with a captivating, intuitive and functional graphics for vehicle repairers.



PARKING AID CAMERAS

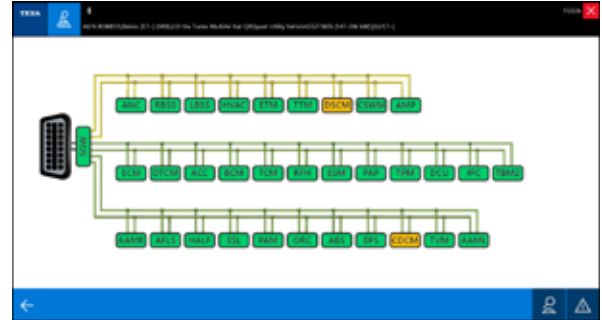

TGS3s DASHBOARDS

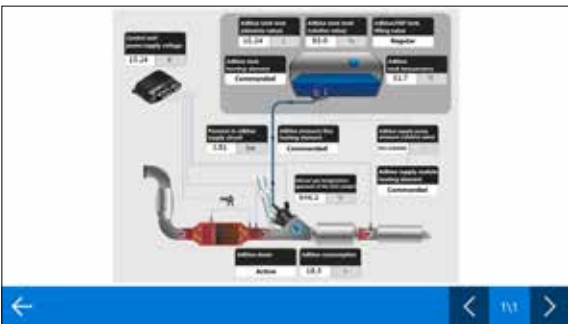

LPG INJECTION

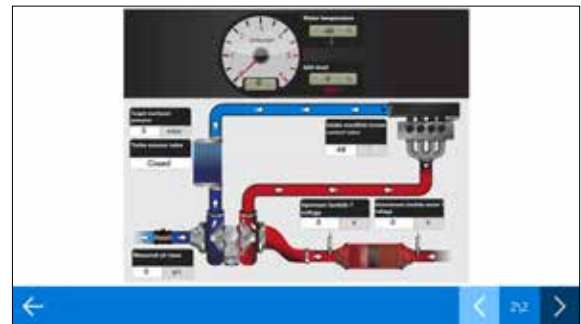

REDUCING AGENT METERING SYSTEM

HYBRID AND ELECTRIC VEHICLES

The IDC5 software boasts a **leader coverage on the market** for hybrid and electric vehicles that can be reached using the Special functions button on the homepage.

over 100 makes;
over 500 models;
over 1.600 diagnostic systems

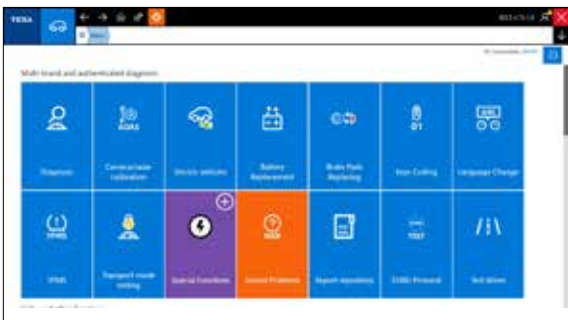

Vehicle selection with a dedicated button

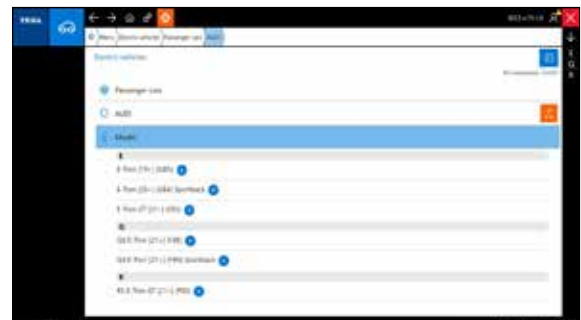

Dedicated vehicle selection

TRUCK Environment

IDC5, TEXPACK and TEX@INFO

The TRUCK IDC5 software guides repairers throughout all the diagnostic phases, from the identification of the error to its solution, for vehicles such as **trucks, buses & coaches, trailers/semi-trailers, light commercial vehicles, Power Train** and **multi-function commercial vehicles**.

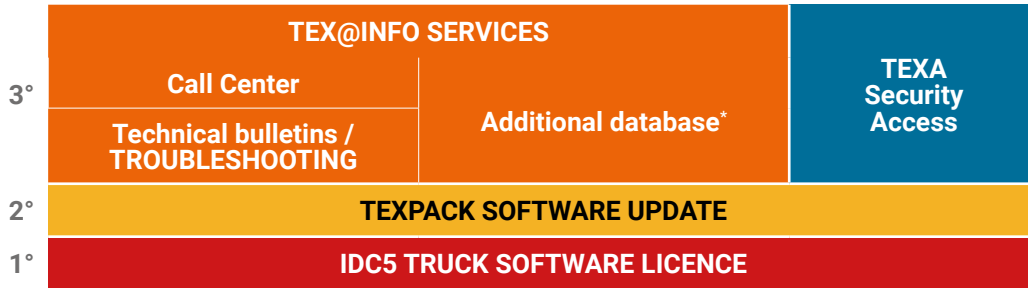

DATABASE INTEGRATED IN IDC5

IDC5 TRUCK, in addition to the repair information already

available inside the software, now also integrates an extensive database with detailed technical information of heavy-duty and light commercial vehicles, divided by category: **Vehicle identification data,**

Maintenance data, Adjustment data, Lubricants and fluids, Repair manuals, Recalls, Repair times, Technical drawings, Fuses and relays, Warning lights and indicators.

To be able to use the new database, you simply need to have an active **TEXPACK TRUCK** contract and request the **TEX@INFO TRUCK - DATABASE** service.



DASHBOARD

Among the exclusive functions offered by the IDC5 operating software, there is the DASHBOARD** that allows displaying the engineering parameters of the

vehicles, associated with an intuitive and captivating graphic design that reproduces a dashboard in an industrial vehicle, the mechanical components and the system's operating logic.

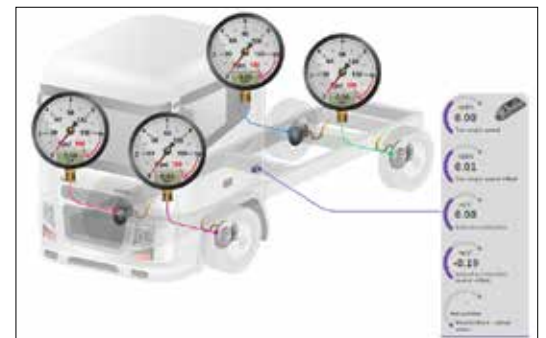

TROUBLESHOOTING

The IDC5 TRUCK software by TEXA also offers access to a database called "Troubleshooting", in which there is a collection of information, additional details and recommended repair procedures for a large variety of

errors that can appear during Self-diagnosis. By entering the error code or description, you will be given the repair procedure recommended by the manufacturer.



* HaynesPro® contents

** The DASHBOARD function is already available and activated for the customers who use the AXONE diagnostic tool. Customers using other diagnostic tools can purchase DASHBOARD as a dedicated app from the "TEXA APP" virtual store.

SPECIAL REPROGRAMMING FUNCTIONS

Specific vehicles and/or systems may require special functions, such as: reprogramming of new generation air dryers (APU: Air Processing Unit/APM: Air Processing Module); programming of ZF As-Tronic® transmissions; advanced configuration of new EBS braking systems on trailers; replacement of electronic control units with the possibility of transferring parameter settings from the old unit to the new one. All these functions can be performed easily and safely in IDC5 TRUCK.



MANUFACTURER CONTROL UNIT AND GATEWAY UNLOCK

FCA GROUP FIAT PROFESSIONAL

Included with **TEXA Security Access**

GUIDED DIAGNOSIS

This new function allows users to perform a guided and in-depth check to solve a problem.

The **guided diagnosis** will show in a **graphic, intuitive and interactive** way the actions to be taken to **perform a specific repair** or to **check a component**, guaranteeing its **solution through suggestions and indications** based on a logical process.

The function is available for the main categories, such as:

- **Engine**
- **Exhaust gas after-treatment**
- **ADAS**
- **Suspensions**
- **Braking system**
- **Air reservoir system**
- **Air conditioning and Heating**



Start from quick menu



Error reading



Start from diagnostic system



Parameter reading with wiring diagram and detected fault

BIKE Environment

IDC5, TEXPACK and TEX@INFO

The IDC5 BIKE software guides repair technicians throughout all the diagnostic phases, from the identification of the error to its solution, for vehicles in the world of Powersports like **motorcycles, e-bikes, snow mobiles, Personal Watercrafts (PWCs) and Side-by-side/ATV.**

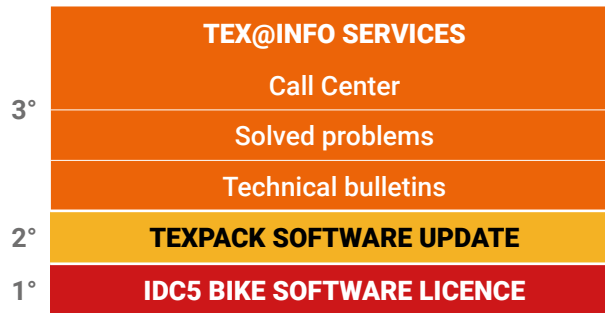

TECHNICAL SHEETS

Very accurate **information on the selected vehicle**, including instructions for performing a manual service reset, the general description of a specific mechatronic system and much more.



GUIDED DIAGNOSIS

Useful to solve a **fault associated with an error code** detected in self-diagnosis. They provide a tree diagram for troubleshooting.



INTERACTIVE WIRING DIAGRAMS

The **animations of the relevant devices** create an interactive map with the flow of input and output signals to/from the control units.

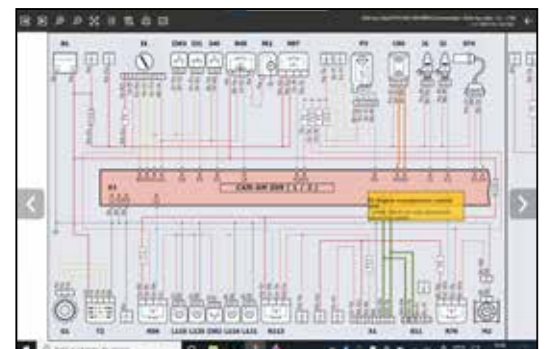

ELECTRIC VEHICLES

The IDC5 BIKE software includes makes such as **Yadea** and **Sunra**, other than an extension of the coverage of brands that are already included such as **Fantic**. Furthermore, TEXA has developed a **specific cable for electric vehicles** for a safe and quick diagnosis on these vehicles.

+ 12 makes

+ 26 models

+ 32 diagnostic systems

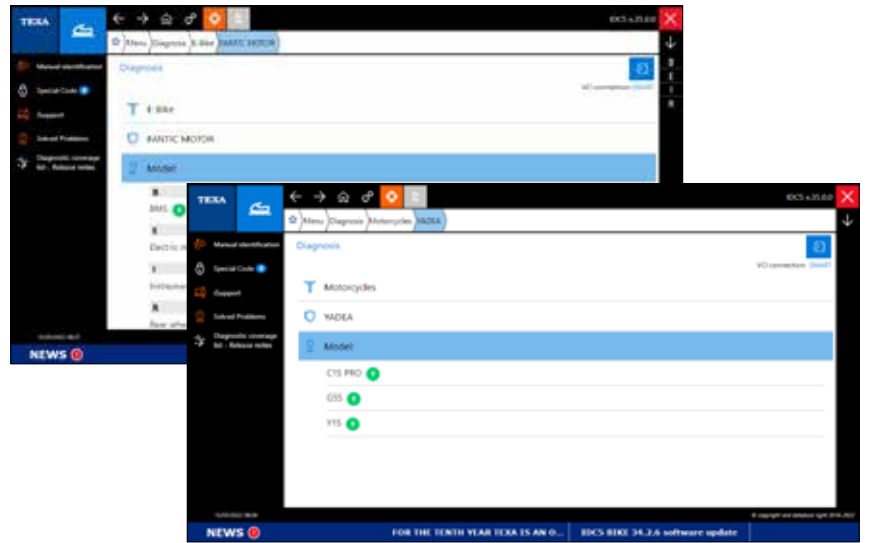

OFFICIAL DUCATI SUPPLIER



OE PARTNERSHIP

IDC5 BIKE is the official diagnostic software chosen by:

AJP, BENELLI Q.J., BETAMOTOR, BIMOTA, BROUGH SUPERIOR, DUCATI, FANTIC MOTOR, F.B MONDIAL, MGK, HELLENIC MOTOR, MOTO MORINI, MV AGUSTA, SWM, SYM ITALIA, PADANA SVILUPPO.

Multi-brand workshops can have the same coverage level as that of the manufacturer.

TECHNICAL PARTNER: ARROW EXHAUST

OHW Environment

IDC5, TEXPACK and TEX@INFO

The IDC5 OHW software guides vehicle repairers throughout all the diagnostic phases, from the identification of the error up to its solution, for vehicles such as **agricultural vehicles, telescopic handlers & forklifts** and **industrial engines**.

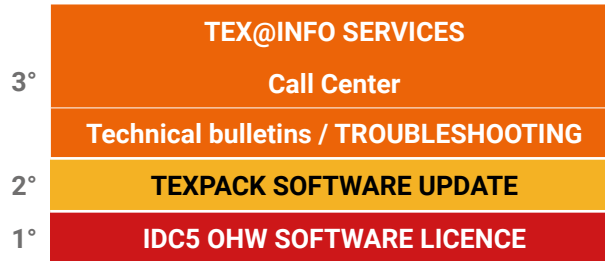

DASHBOARD

Among the exclusive functions offered by the IDC5 operating software, there is the DASHBOARD* that allows displaying the engineering parameters of the vehicles, associated with an intuitive and captivating graphic design that reproduces a dashboard in an industrial vehicle, the mechanical components and the system's operating logic.



* The DASHBOARD function is already available and activated for the customers who use the AXONE diagnostic tool. Customers using other diagnostic tools can purchase DASHBOARD as a dedicated app from the "TEXA APP" virtual store.



TROUBLESHOOTING

The IDC5 TRUCK software by TEXA also offers access to a database called "Troubleshooting", in which there is a collection of information, additional details and recommended repair procedures for a large variety of errors that can appear during Self-diagnosis. By entering the error code or description, you will be given the repair procedure recommended by the manufacturer.

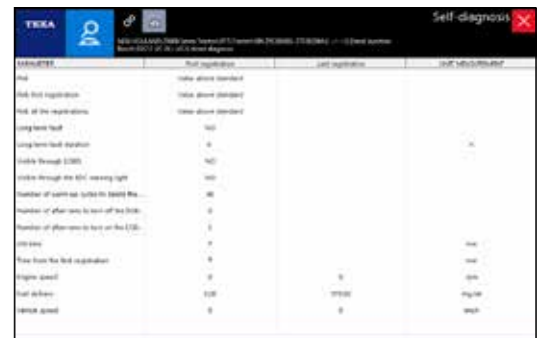

REC & PLAY DIAGNOSTIC SESSION RECORDING

A fault may occur in a vehicle under specific operating conditions only: for example, power may be lost only when driving uphill or when the engine is under a high load, or perhaps a warning light comes on only when the engine is hot. In cases like these you can use the Rec&Play function that allows recording parameters and errors that occur during a test drive. Data can be viewed and analysed later and even printed out as a report on the test. Users can find detailed and comprehensive information on Mechanical Specifications, Wheel Alignment, Tyre Pressures, Timing Belt, Routine Maintenance, Component Locations, Component Testing and much more.

GUIDED DIAGNOSIS

This new function allows users to perform a guided and in-depth check to solve a problem.

The **guided diagnosis** will show in a **graphic, intuitive** and **interactive** way the actions to be taken to **perform a specific repair** or to **check a component**, guaranteeing its **solution through suggestions and indications** based on a logical process.

The function is available for the main categories, such as:

- **Engine**
- **Exhaust gas after-treatment**
- **Air conditioning and Heating**

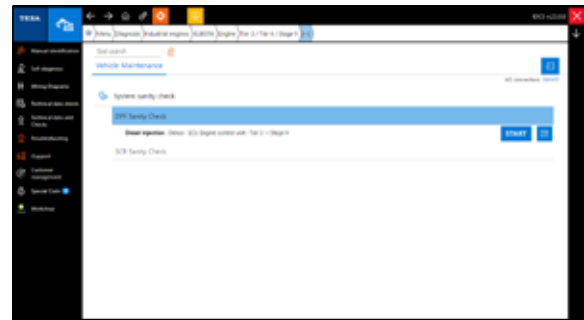

Start from quick menu



Error reading



Error parameter reading with help sheet and component sheet

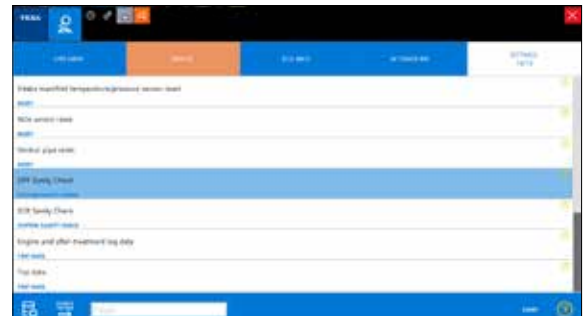

Start from diagnostic system



Error parameter reading with technical sheet



Parameter reading with wiring diagram and detected fault

MARINE Environment

IDC5, TEXPACK and TEX@INFO

The IDC5 MARINE software guides repair technicians throughout all the diagnostic phases, from the identification of the error to its solution, on **inboard engines, outboard engines, industrial engines & generators and Personal Watercrafts (PWCs)**.



TECHNICAL SHEETS

Very accurate **information on the selected vehicle**, including instructions for performing a manual service reset, the general description of a specific mechatronic system and much more.



GUIDED DIAGNOSIS

Useful to solve a **fault associated with an error code** detected in self-diagnosis. They provide a tree diagram for troubleshooting.



INTERACTIVE WIRING DIAGRAMS

The **animations of the relevant devices** create an interactive map with the flow of input and output signals to/from the control units.

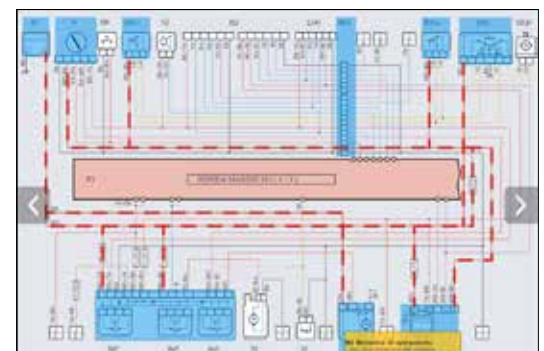

SPECIAL ADJUSTMENTS

The special adjustments are an advanced, characteristic functionality by TEXA. They allow carrying out far more complex operations than the basic adjustments.



Maintenance service - online service function

OFFICIAL SELVA MARINE SUPPLIER



OFFICIAL TOHATSU ITALIA SUPPLIER



TEXAEDU training

TEXAEDU is the division in TEXA entirely dedicated to the **technical automotive** training that offers a complete educational programme **for specialised mechatronics** in the field founded on:

- Over **50 courses available** specific for all the diagnostic environments: CAR, TRUCK, BIKE, OHW and MARINE.
- **Innovative educational tools** that allow interactions for a more efficient training.
- **Certified training structures**, equipped with the latest generation diagnostic instrumentation, by authorised TEXA distributors.
- **Highly qualified technical trainer personnel**
- The **complete training process is ISO EA37 certified**.

Our numbers in 2023



+ 500 courses



+ 4.000 hours of training



+ 5.000 participants

The training offer is enriched by courses available in 2 modes:



- **IN CLASS** inside educational structures equipped with the latest generation diagnostic instrumentation, with practical tests carried out directly on the vehicles.



- **ONLINE in VIDEOCONFERENCE** live with qualified trainers. This method is integrated by interactive practical tests, simulations of practical cases and guided solutions of the most common
- **ONLINE**, accessible autonomously within the eLearning platform, complete with test and multimedia drills.

Classroom and online courses with the release of a certificate and qualification:



A/C QUALIFICATION

It is a qualifying course for the personnel in charge of recovering the fluorinated gases from motor vehicles in compliance with the Regulation 307/2008.



PES/PAV

STANDARD CEI 11-27. It is a training course for the PES/PAV QUALIFICATION, procedures for working safely on hybrid and electric vehicles, levels 1A, 2A, 1B and 2B.



MECHATRONIC TECHNICIAN

Qualifying course for Vehicle repair Mechatronic Technicians Accredited training entity.



Scan the QR CODE for the complete list and updated calendar of the scheduled courses

Solutions, compatibility and software

	AXONE NEMO LIGHT	AXONE NEMO PLUS	AXONE VOICE	Navigator NANO S	Navigator TXB 2	Navigator TXB Zero	TXT MULTIHUB	DoIP NODE	CAN FD Adapter	Info Connect 2	TPS2	RCCS 3 EVO	CCS 2 Dynamics	eTRUCK	eLight ONE / ONE ^D	eLight ZERO	LASER EXAMINER 2	TTC	TwinProbe / UNIProbe	GASBOX2 / OPABOX	GAS MOBILE	RC3 REV COUNTER	RCM	H2 BLASTER	KONFORT	TXR ID	AIR2 SAN	IDC5	Dedicated APP	Stand alone
HARDWARE																														
AXONE NEMO LIGHT				●	●		●			●		●	●		●		●		●	●		●					●	●		
AXONE NEMO PLUS				●	●		●			●		●	●		●		●		●	●		●					●	●		
AXONE VOICE				●	●		●			●		●	●		●		●		●	●		●					●	●		
Navigator NANO S	●	●	●					●	●			●	●		●												●	●		
Navigator TXB 2	●	●	●																								●	●		
Navigator TXB Zero																											●	●		
TXT MULTIHUB	●	●	●						●			●	●														●	●		
DoIP NODE				●																							●	●		
CAN FD Adapter				●			●																				●	●		
Info Connect 2	●	●	●																								●	●		
TPS2																													●	
RCCS 3 EVO	●	●	●	●			●																				●	●		
CCS 2 Dynamics	●	●	●	●			●																				●	●		
eTRUCK																												●		
eLight ONE / ONE ^D	●	●	●	●																							●	●		
eLight ZERO																													●	
LASER EXAMINER 2	●	●	●																									●		
TTC																													●	
TwinProbe / UNIProbe	●	●	●																								●	●		
GASBOX2 / OPABOX	●	●	●																			●	●	●			●	●		
GAS MOBILE																					●	●	●				●	●		
RC3 REV COUNTER	●	●	●																		●	●					●	●		
RCM																					●	●						●	●	
H2 BLASTER																													●	
KONFORT																													●	●
TXR ID																													●	●
AIR2 SAN	●	●	●	●																							●	●		
Management SOFTWARE																														
IDC5	●	●	●	●	●	●	●	●	●	●		●	●		●				●	●	●						●			
Dedicated APP															●		●								●	●	●			
Stand alone											●					●	●				●	●	●	●	●	●	●			



Simplifying the present, anticipating the future



Founded in 1992
30,000 covered sq. m
in an area of over 100.000 mq
2 new plants



8 subsidiaries
in the world



Approximately 1,000 TEXA
employees in the world
over 400 technical profiles



700 Distributors
over 200,000 active
customer workshops



Patents
58 Master, 110 total



Certifications
ISO 9001
IATF 16949
E.P.A.
ISO/IEC27001
TISAX
ISO 14001:2015

WARNING

The trademarks and logos of vehicle manufacturers in this document have been used exclusively for information purposes and are used to clarify the compatibility of TEXA products with the models of vehicles identified by the trademarks and logos. Because TEXA products and software are subject to continuous developments and updates, upon reading this document they may not be able to carry out the DIAGNOSTICS of all the models and electronic systems of each vehicle manufacturer mentioned within this document. References to the makes, models and electronic systems within this document must therefore be considered purely indicative and TEXA recommends to always check the list of the "Systems that can be diagnosed" of the product and/or software at TEXA authorised retailers before any purchase. **The images and the vehicle outlines within this document have been included for the sole purpose of making it easier to identify the vehicle category (car, truck, motorbike, etc.) for which the TEXA product and/or software is intended.** The data, descriptions and illustrations may change compared to those described in this document. TEXA S.p.A. reserves the right to make changes to its products without prior notice.

To check out the extensive coverage of TEXA products, go to: www.texa.com/coverage

To check on IDC5 compatibility and minimum system requirements, go to: www.texa.com/system

Apple and Apple Logo are trademarks of Apple Inc.

Google Play and Google Play Logo are trademarks of Google LLC.

The Bluetooth® brand is the property of Bluetooth SIG, Inc., U.S.A., and is used by TEXA S.p.A. under license.



Visit our website
www.texa.com

Scan the QR code and
follow us on our social media!

Copyright TEXA S.p.A.
cod. 8801883
04/2024 - Inglese - V32



TEXA

TEXA S.p.A.
Via 1 Maggio, 9
31050 Monastier di Treviso
Treviso - ITALY
Tel. +39 0422 791311
Fax +39 0422 791300
www.texa.com - info.it@texa.com

COMPANY WITH
QUALITY SYSTEM
CERTIFIED BY DNV
[ISO 9001](https://www.iso.org/)